

VETRINETTE COLLECTION



ARTELINEA
FIRENZE 1962

COLONNE
VETRINETTE

VETRINETTE Collection

Note:

- 37 **Vetrine affiancabili e sovrapponibili.**
Combinable wall units.
Vitrinas componibles o sobrepuesta.

CARATTERISTICHE TECNICHE DEL PRODOTTO

TECHNICAL CHARACTERISTICS

CARACTERÍSTICAS TÉCNICAS DEL PRODUCTO

STRUTTURA - STRUCTURE - ESTRUCTURA

Schienale metallico rivestito di cristallo spessore 4 mm o Laminam®. Cornici e mensole interne in cristallo extrachiaro spessore 8 mm.

Metal back covered in 4 mm enameled glass or Laminam®. Frames and inner shelves in 8 mm extraclear glass.

Trasera de metal revestida de cristal esmaltado grosor 4 mm o Laminam. Cornisas y repisas internas de cristal extraclaro grosor 8 mm.



Vetrine pensili.

Wall cabinets.

Vitrina de colgar.

Cristallo smaltato
Enameled crystal
 Cristal esmaltado
LAMINAM®

Note: **37** (pag. 318)

Vetrina uso mensola - Posizionabile in orizzontale o verticale.

Wall cabinet - Can be positioned horizontally or vertically.

Vitrina uso estante. Posizionabile in orizzontale o verticale.

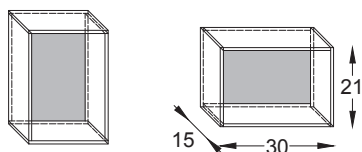

L cm	Art.
30	VT230

Note: **37** (pag. 318)

Vetrina uso mensola - Posizionabile in orizzontale o verticale.

Wall cabinet - Can be positioned horizontally or vertically.

Vitrina uso estante. Posizionabile in orizzontale o verticale.

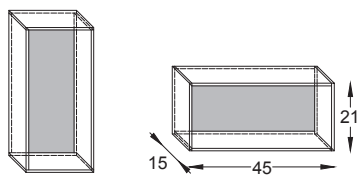

L cm	Art.
45	VT245

Note: **37** (pag. 318)

Vetrina uso mensola - Posizionabile in orizzontale o verticale.

Wall cabinet - Can be positioned horizontally or vertically.

Vitrina uso estante. Posizionabile in orizzontale o verticale.

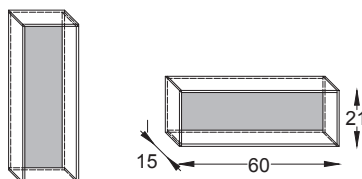

L cm	Art.
60	VT260

Note: **37** (pag. 318)

Vetrina uso mensola - Posizionabile in orizzontale o verticale.

Wall cabinet - Can be positioned horizontally or vertically.

Vitrina uso estante. Posizionabile in orizzontale o verticale.

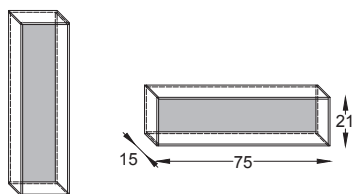

L cm	Art.
75	VT275

Vetrine pensili.

Wall cabinets.

Vitrina de colgar.

Cristallo smaltato
Enameled crystal
 Cristal esmaltado
LAMINAM®

Note: **37** (pag. 318)

Vetrina ad uso mensola.

Wall cabinet.

Vitrina uso estante.

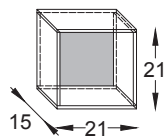

Art.

VT211

Note: **37** (pag. 318)

Vetrina 2 scomparti. Posizionabile in orizzontale e verticale.

Wall cabinet with 2 sections. Can be positioned horizontally or vertically.

Vitrina 2 compartimentos. Posicionable en horizontal o vertical.

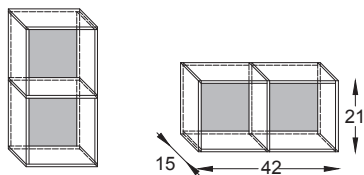

Art.

VT212

Note: **37** (pag. 318)

Vetrina 3 scomparti. Posizionabile in orizzontale e verticale.

Wall cabinet with 3 sections. Can be positioned horizontally or vertically.

Vitrina 3 compartimentos. Posicionable en horizontal o vertical.

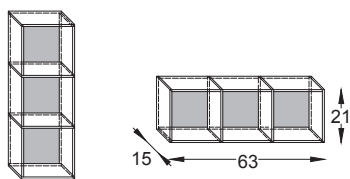

Art.

VT213

Note: **37** (pag. 318)

Vetrina 4 scomparti. Posizionabile in orizzontale e verticale.

Wall cabinet with 4 sections. Can be positioned horizontally or vertically.

Vitrina 4 compartimentos. Posicionable en horizontal o vertical.

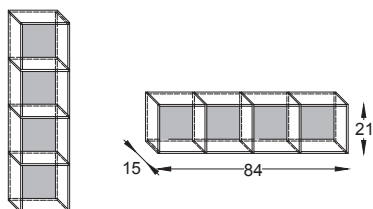

Art.

VT214

Colori vedi pag. 12/15. - Colours see pages 12/15 - Colores ver pág. 12/15.

Vetrine pensili.

Wall cabinets.

Vitrina de colgar.

Cristallo smaltato
Enameled crystal
 Cristal esmaltado
LAMINAM®

Note: **37** (pag. 318)

Vetrina 5 scomparti. Posizionabile in orizzontale e verticale.

Wall cabinet with 5 sections. Can be positioned horizontally or vertically.

Vitrina 5 compartimentos. Posicionable en horizontal o vertical.

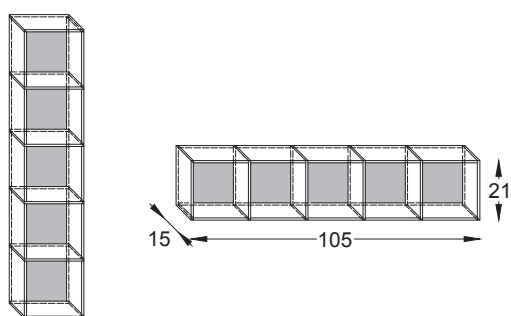

Art.

VT215

Note: **37** (pag. 318)

Vetrina 6 scomparti. Posizionabile in orizzontale e verticale.

Wall cabinet with 6 sections. Can be positioned horizontally or vertically.

Vitrina 6 compartimentos. Posicionable en horizontal o vertical.

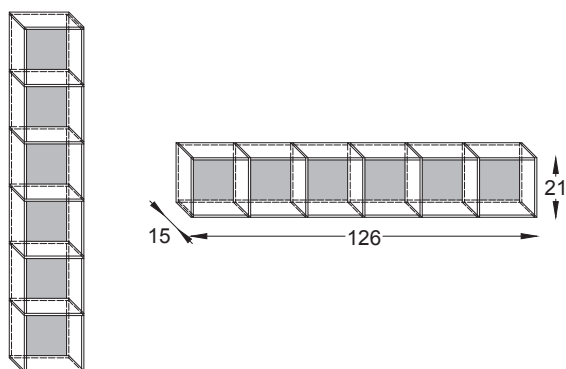

Art.

VT216

Vetrine pensili.

Wall cabinets.

Vitrina de colgar.

Cristallo smaltato
Enameled crystal
 Cristal esmaltado
LAMINAM®

Note: **37** (pag. 318)

Vetrina ad uso mensola.

Wall cabinet.

Vitrina uso estante.

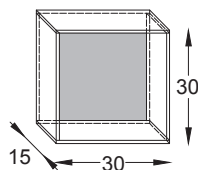

Art.

VT301

Note: **37** (pag. 318)

Vetrina 2 scomparti. Posizionabile in orizzontale e verticale.

Wall cabinet with 2 sections. Can be positioned horizontally or vertically.

Vitrina 2 compartimentos. Posicionable en horizontal o vertical.

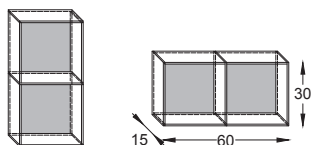

Art.

VT302

Note: **37** (pag. 318)

Vetrina 3 scomparti. Posizionabile in orizzontale e verticale.

Wall cabinet with 3 sections. Can be positioned horizontally or vertically.

Vitrina 3 compartimentos. Posicionable en horizontal o vertical.

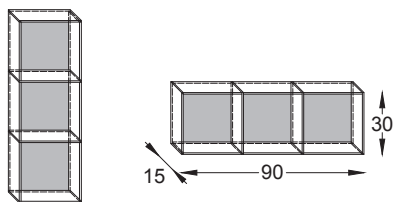

Art.

VT303

Note: **37** (pag. 318)

Vetrina 4 scomparti. Posizionabile in orizzontale e verticale.

Wall cabinet with 4 sections. Can be positioned horizontally or vertically.

Vitrina 4 compartimentos. Posicionable en horizontal o vertical.

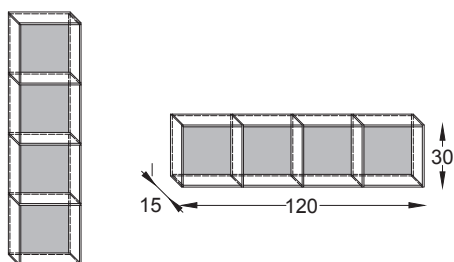

Art.

VT304

Colori vedi pag. 12/15. - Colours see pages 12/15 - Colores ver pág. 12/15.

Vetrine pensili.

Wall cabinets.

Vitrina de colgar.

Cristallo smaltato
Enameled crystal
 Cristal esmaltado
LAMINAM®

Note: **37** (pag. 318)

Vetrina con mensolina intermedia (Reversibile).

Wall cabinet with dividing shelf (Reversible).

Vitrina con e stante intermedio. [Reversible].

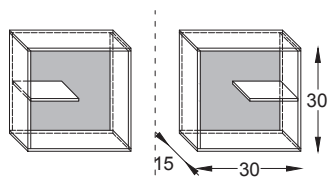

Art.

VT311

Note: **37** (pag. 318)

Vetrina 2 scomparti e mensoline intermedie (Reversibile).

Wall cabinet with 2 sections and dividing shelves (Reversible).

Vitrina 2 compartimentos y estantes intermedios (Reversible).

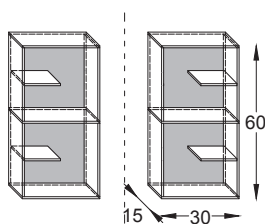

Art.

VT312

Note: **37** (pag. 318)

Vetrina 3 scomparti e mensoline intermedie (Reversibile).

Wall cabinet with 3 sections and dividing shelves (Reversible).

Vitrina 3 compartimentos y estantes intermedios (Reversible).

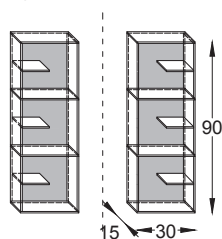

Art.

VT313

Note: **37** (pag. 318)

Vetrina 4 scomparti e mensoline intermedie (Reversibile).

Wall cabinet with 4 sections and dividing shelves (Reversible).

Vitrina 4 compartimentos y repisas intermedias. (Reversible).

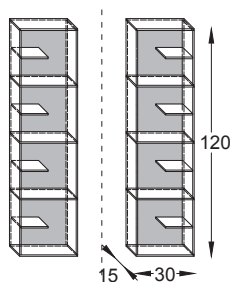

Art.

VT314

Vetrine pensili.

Wall cabinets.

Vitrina de colgar.

Cristallo smaltato lucido
Enameled glossy glass
 Cristal esmaltado
LAMINAM®

Note: **37** (pag. 318)

Vetrina pensile a giorno con 2 vani (Reversibile).

Wall unit with 2 sections (Reversible).

Repisa con 2 espacios (Reversible).

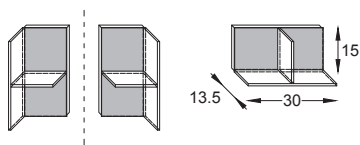

Art.

DQM30A

Note: **37** (pag. 318)

Vetrina pensile a giorno con 2 vani (Reversibile).

Wall unit with 2 sections (Reversible).

Repisa con 2 espacios (reversible).

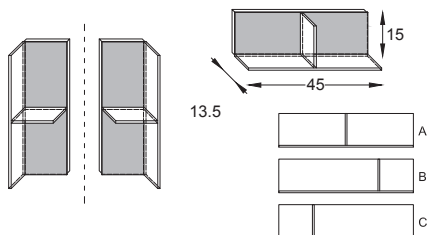

Art.

DQM45A

DQM45B

DQM45C

Note: **37** (pag. 318)

Vetrina pensile a giorno con 2 vani (Reversibile).

Wall unit with 2 sections (Reversible).

Repisa con 2 espacios (Reversible).

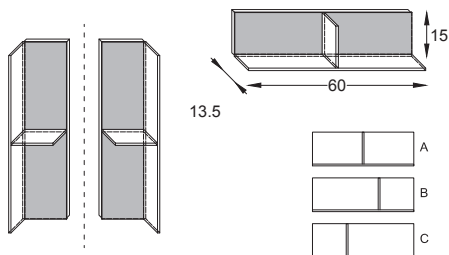

Art.

DQM60A

DQM60B

DQM60C

Note: **37** (pag. 318)

Vetrina pensile a giorno con 3 o 4 vani (Reversibile).

Wall unit with 3 or 4 sections (Reversible).

Repisa con 3 o 4 espacios (Reversible).

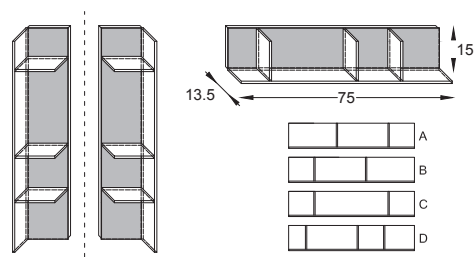

Art.

DQM75A

DQM75B

DQM75C

DQM75D

Colori vedi pag. 12/15. - Colours see pages 12/15 - Colores ver pág. 12/15.

Vetrine pensili.

Wall cabinets.

Vitrina de colgar.

Cristallo smaltato lucido
Enameled glossy glass
 Cristal esmaltado
LAMINAM®

Note: **37** (pag. 318)

Vetrina pensile a giorno con 3 vani (Reversibile).

Wall unit with 3 sections (Reversible).

Repisa con 3 espacios (Reversible).

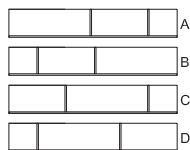
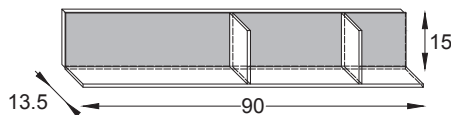
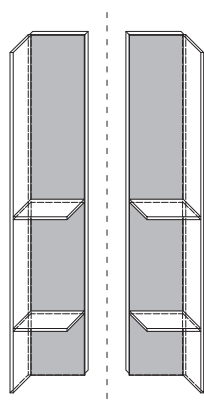

Art.

DQM90A	
DQM90B	
DQM90C	
DQM90D	

Note: **37** (pag. 318)

Vetrina pensile a giorno con 4 o 5 vani (Reversibile).

Wall unit with 4 or 5 sections (Reversible).

Repisa con 4 o 5 espacios. (Reversible).

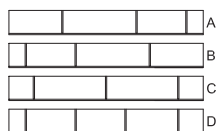
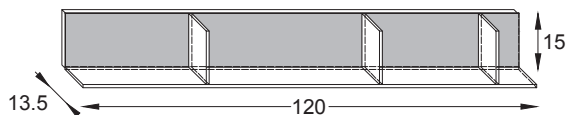
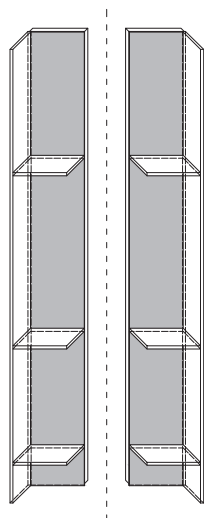

Art.

DQM120A	
DQM120B	
DQM120C	
DQM120D	

Vetrine pensili.

Wall cabinets.

Vitrina de colgar.

Vetrina pensile a giorno con schienale a specchio o bianco assoluto spessore 5 mm con 4 ripiani in cristallo extrachiaro spessore 8 mm.

Shelf unit with back covered in 5 mm mirrored or bianco assoluto glass, with 4 glass shelves 8 mm thickness.

Vitrina de colgar con trasera a espejo o blanco absoluto grosor 5 mm con 4 estantes de cristal extraclaro grosor 8 mm.

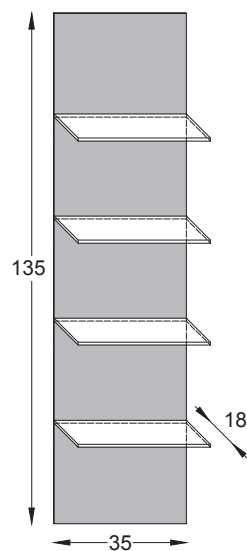

Art.

DM.73 S	Specchio 02
DM.73 B	Bianco assoluto 30

