

FLASH COLLECTION

4 mm smooth edged mirrors with internal LED lighting (LED BAND), 220V transformer, complete with wall mount with or without LED diffusion. LED band slightly curved in the corners. 4000°K light supplied as standard, 2700°K warm light and 6000°K cold light upon request. **NEW front DIMMER SWITCH.** Upon request sensor switch instead of dimmer switch.

Miroirs 4 mm, bords droits avec éclairage intérieur à LED (LED BAND), transformateur 220V avec ou sans éclairage par LED Diffusion. Système de fixation murale inclus. Angles led bande légèrement arrondis. LUMIÈRE NATURELLE 4000°K standard, sur demande LUMIÈRE CHAUDE 2700°K ou FROIDE 6000°K. Fournis avec le NOUVEL INTERRUPTEUR LUMINEUX DIMMER frontal (sur demande avec interrupteur sensor).

Spiegel 4 mm stark, mit rechteckigem Kantenschliff und integrierter Beleuchtung (LED BAND), 220V Transformator, Sensorschalter und Wandbefestigung - erhältlich mit oder ohne LED Diffusion (indirekte Beleuchtung). Der satinierter LED BAND Lichtausschnitt ist an den äußeren Enden leicht abgerundet. Serienmäßig NATURLICHES LICHT 4000°K, auf Wunsch KALT LICHT 6000°K oder WARMLICHT 2700°K. Die Beleuchtung wird durch den neuen DIMMER an der Vorderseite des Spiegels eingeschaltet. Auf Anfrage mit Sensorschalter möglich, anstatt frontaler Dimmer.

NEW DIMMER

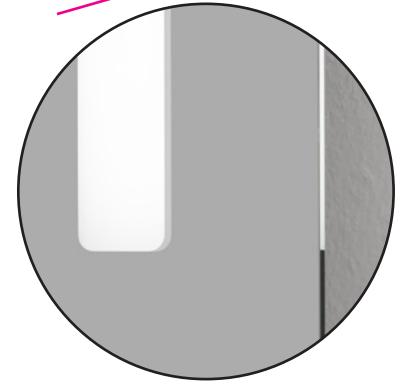

LED BAND 360° + LED DIFFUSION

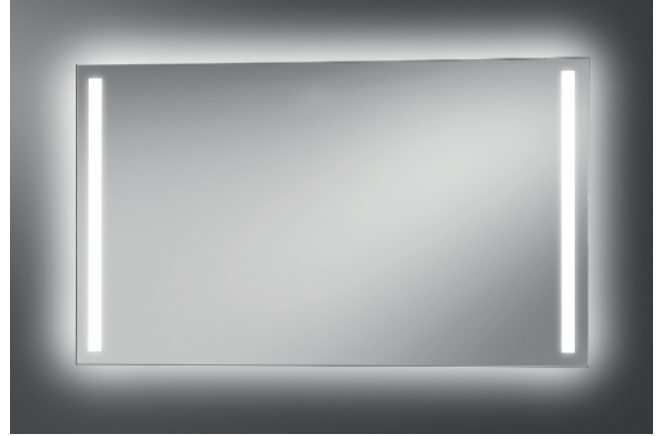

LED BAND + LED DIFFUSION



LED BAND + LED DIFFUSION

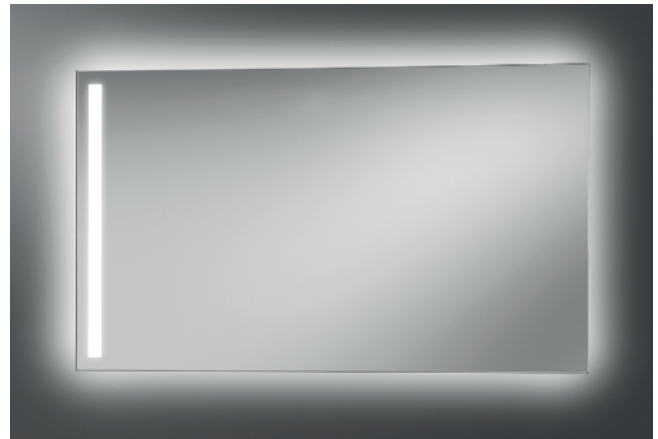

LED BAND + LED DIFFUSION



LED BAND + LED DIFFUSION

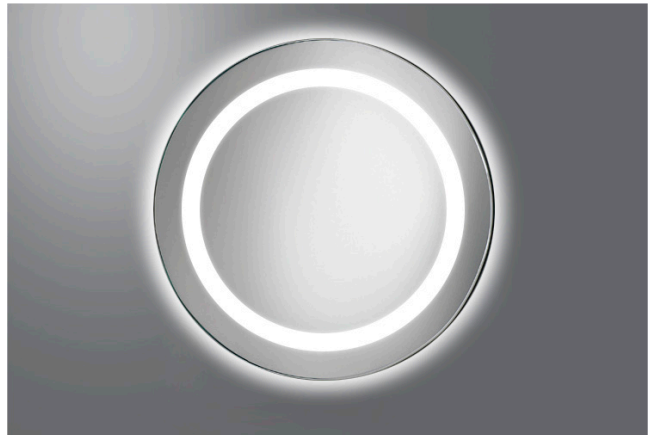

LED BAND + LED DIFFUSION

FLASH Collection

DIMMER INCLUDED
DIMMER INCLUS
Mit DIMMER

MIRRORS *MIROIRS* SPIEGEL

OPTIONAL

Note: (Pag. 94)

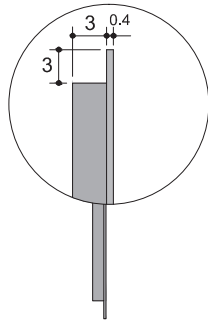

A

LED BAND 360°

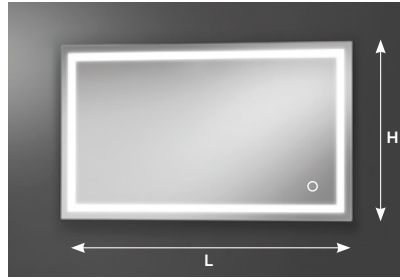

Art. TF4

L cm (Standard)

H 70 cm H 80 cm H 90 cm H 100 cm

- 60
- 75
- 90
- 105
- 120
- 135
- 150
- 165
- 180
- 195
- 210

L cm (Custom)

from/de/von to/a/bis

- 60 → 90
- 91 → 120
- 121 → 150
- 151 → 180
- 181 → 210

MUS
Pag.98

MIX
Pag.100

SLG
Pag.101

MM10
Pag.103

MM12
Pag.103

NOF
Pag.104

OBL
Pag.105

ING1
Pag.106

SPECCHI
MIRRORS
LIGHTING

FLASH Collection

DIMMER INCLUDED
DIMMER INCLUS
Mit DIMMER

MIRRORS *MIROIRS* SPIEGEL

Note: (Pag. 94)

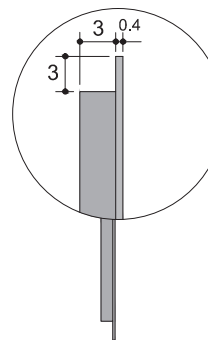

A V X

LED BAND 360° + LED DIFFUSION

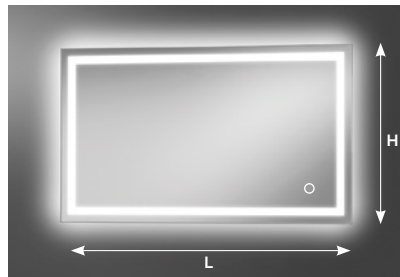

Art. TFD4

L cm (Standard)

H 70 cm H 80 cm H 90 cm H 100 cm

- 60
- 75
- 90
- 105
- 120
- 135
- 150
- 165
- 180
- 195
- 210

L cm (Custom)

from/de/von to/a/bis

- 60 → 90
- 91 → 120
- 121 → 150
- 151 → 180
- 181 → 210

OPTIONAL

FLASH Collection

DIMMER INCLUDED
DIMMER INCLUS
Mit DIMMER

MIRRORS *MIROIRS* SPIEGEL

Note: (Pag. 94)

MUS
Pag.98

MIX
Pag.100

SLG
Pag.101



MM10
Pag.103

MM12
Pag.103

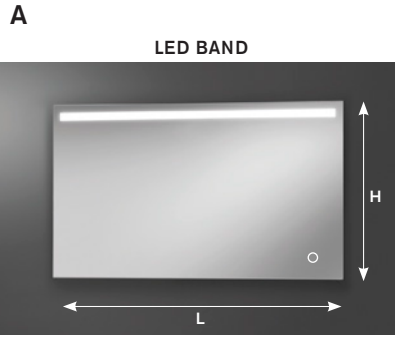
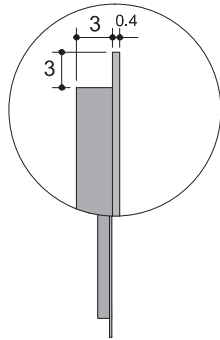

NOF
Pag.104

OBL
Pag.105

ING1
Pag.106

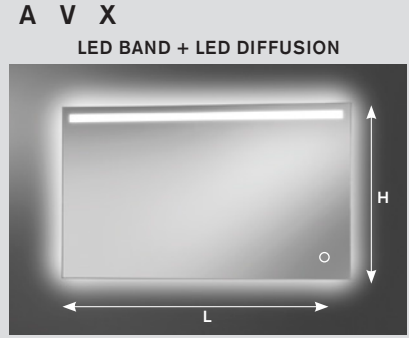

Art. TFO1



Art. TFDO1

L cm (Standard)

H 60 cm H 70 cm H 80 cm H 90 cm

H 60 cm H 70 cm H 80 cm H 90 cm

- 45
- 60
- 75
- 90
- 105
- 120
- 135
- 150
- 165
- 180
- 195
- 210
- 225

L cm (Custom)

from/de/von	to/a/bis
45	→ 60
61	→ 99
100	→ 139
140	→ 179
180	→ 204
205	→ 225

FLASH Collection

DIMMER INCLUDED
DIMMER INCLUS
Mit DIMMER

MIRRORS *MIROIRS* SPIEGEL

Note: (Pag. 94)

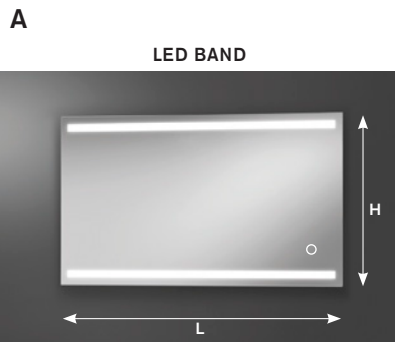
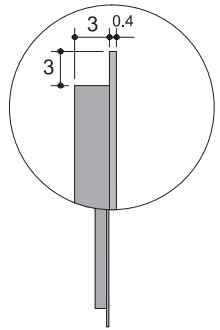

Art. TFO2

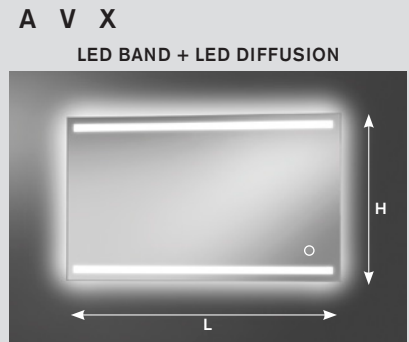

Art. TFDO2

L cm (Standard)

H 70 cm H 80 cm H 90 cm

H 70 cm H 80 cm H 90 cm

- 45
- 60
- 75
- 90
- 105
- 120
- 135
- 150
- 165
- 180
- 195
- 210
- 225

L cm (Custom)

from/de/von	to/a/bis
45	→ 60
61	→ 99
100	→ 139
140	→ 179
180	→ 204
205	→ 225

FLASH Collection

DIMMER INCLUDED
DIMMER INCLUS
Mit DIMMER

MIRRORS *MIROIRS* SPIEGEL

OPTIONAL

Note: (Pag. 94)

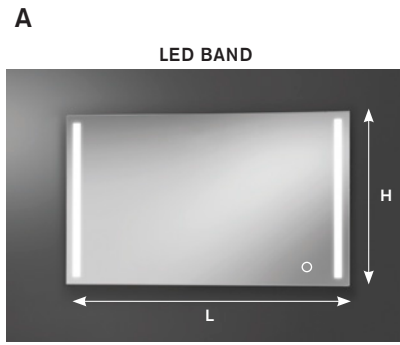
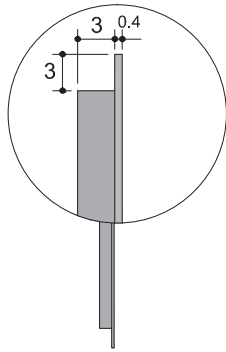

Art. TFV2

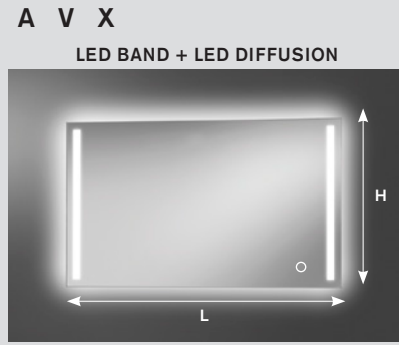

Art. TFDV2

L cm (Standard)

H 70 cm H 80 cm H 90 cm

- 45
- 60
- 75
- 90
- 105
- 120
- 135
- 150
- 165
- 180
- 195
- 205

L cm (Custom)

from/de/von	to/a/bis
45	→ 60
61	→ 99
100	→ 139
140	→ 179
180	→ 205

A V X

LED BAND + LED DIFFUSION

H 70 cm H 80 cm H 90 cm

MUS
Pag.98

MIX
Pag.100

SLG
Pag.101

MM10
Pag.103

MM12
Pag.103

NOF
Pag.104

OBL
Pag.105

ING1
Pag.106

W
Pag.189

SPECCHI
MIRRORS
LIGHTING

FLASH Collection

DIMMER INCLUDED
DIMMER INCLUS
Mit DIMMER

MIRRORS *MIROIRS* SPIEGEL

Note: (Pag. 94)

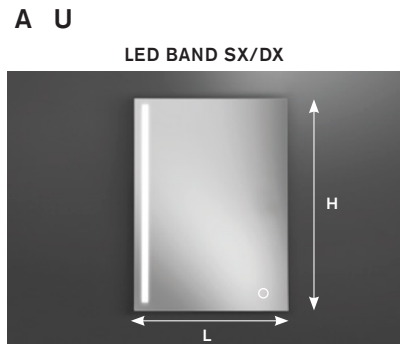
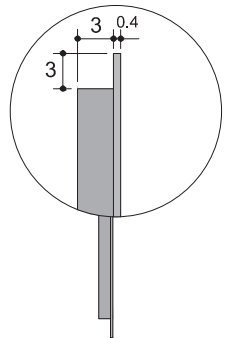

Art. TFS1sx - TFD1dx

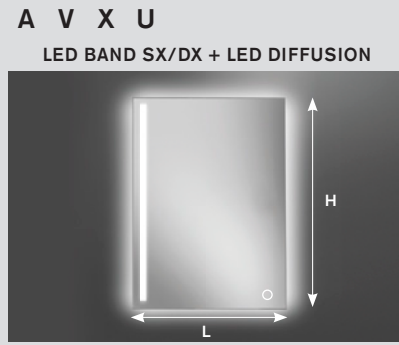

Art. TFDS1sx - TFDD1dx

H cm

L 50 cm L 70 cm
L 60 cm L 80 cm

L 50 cm L 70 cm
L 60 cm L 80 cm

from/de/von	to/a/bis
60	→ 99
100	→ 139
140	→ 179
180	→ 205

OPTIONAL

FLASH Collection

DIMMER INCLUDED
DIMMER INCLUS
Mit DIMMER

MIRRORS *MIROIRS* SPIEGEL

Note: (Pag. 94)

MUS
Pag.98

MIX
Pag.100

SLG
Pag.101



MM10
Pag.103

MM12
Pag.103

NOF
Pag.104

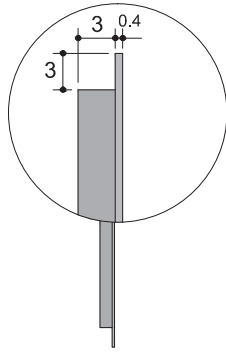

OBL
Pag.105

ING1
Pag.106

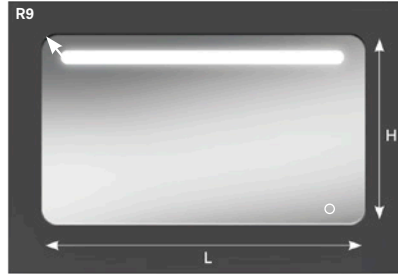

A

LED BAND



Art. TFRO1

A V X

LED BAND + LED DIFFUSION

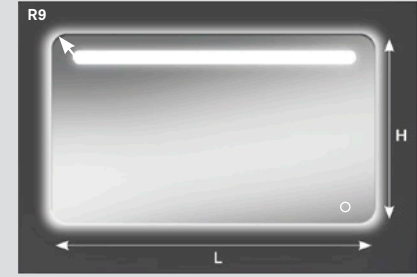

Art. TFRDO1

L cm (Standard)

H 60 cm

H 70 cm

H 80 cm

H 90 cm

H 60 cm

H 70 cm

H 80 cm

H 90 cm

45

60

75

90

105

120

135

150

165

180

195

205

L cm (Custom)

from/de/von to/a/bis

45 → 60

61 → 99

100 → 139

140 → 179

180 → 205

FLASH Collection

DIMMER INCLUDED
DIMMER INCLUS
Mit DIMMER

MIRRORS *MIROIRS* SPIEGEL

Note: (Pag. 94)

NOF
Pag.104



OBL
Pag.105

ING1
Pag.106

OBLO'
Solo Luce
Naturale
4000°K.

*OBLO' lumière
naturelle
4000°K
uniquement*

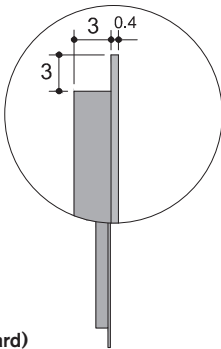
OBLO' nur mit
natürlichem
Licht (4000°K)
erhältlich.



A

LED BAND + OBLO'

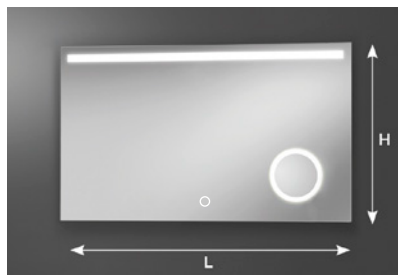

Art. TES1sx - TED1dx

H 70 cm

H 80 cm

H 90 cm

A V X

LED BAND + OBLO' + LED DIFFUSION

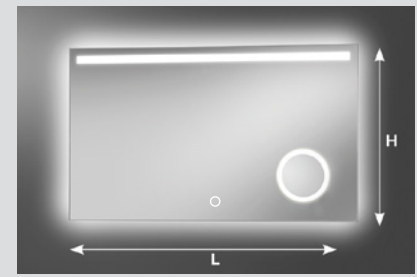

Art. TEDS1sx - TEDD1dx

H 70 cm

H 80 cm

H 90 cm

L cm (Standard)

75

90

105

120

135

150

165

180

195

210

225

L cm (Custom)

from/de/von to/a/bis

75 → 99

100 → 139

140 → 179

180 → 204

205 → 225

For any detail regarding the magnifying mirror see page. 105. - Pour spécifications techniques miroir grossissant, voir p. 105. - Weitere Details über den Vergrößerungsspiegel (Seite105).

FLASH Collection

DIMMER INCLUDED
DIMMER INCLUS
Mit DIMMER

MIRRORS *MIROIRS* SPIEGEL

OPTIONAL

Note: (Pag. 94)

A

4 mm smooth edged mirrors with internal LED lighting (LED BAND), with 220V transformer and wall mount. 4000°K NATURAL LIGHT supplied as standard, 2700°K WARM LIGHT and 6000°K COLD LIGHT upon request. NEW front DIMMER SWITCH.

Miroirs 4 mm, bords droits avec éclairage intérieur à LED (LED BAND), transformateur 220V. Système de fixation murale inclus. LUMIÈRE NATURELLE 4000°K standard, sur demande LUMIÈRE CHAUDE 2700°K ou FROIDE 6000°K. Fournis avec le NOUVEL INTERRUPTEUR LUMINEUX DIMMER frontal (sur demande avec interrupteur sensor).

Spiegel 4 mm stark, mit rechteckigem Kantenschliff und integrierter Beleuchtung (LED BAND), 220V Transformator, Sensorschalter und Wandbefestigung. Serienmäßig NATÜRLICHES LICHT 4000°K, auf Wunsch KALT LICHT 6000°K oder WARMLICHT 2700°K. Die Beleuchtung wird durch den neuen DIMMER an der Vorderseite des Spiegels eingeschaltet.

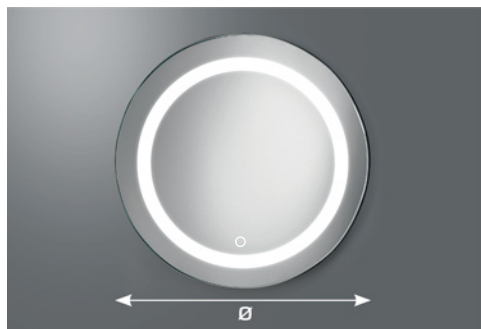
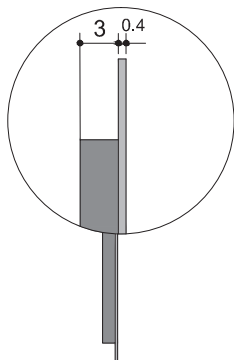

Art. TE90

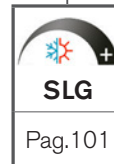
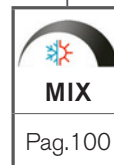

SPECCHI
MIRRORS
LIGHTING

Art. Ø cm.

TE90 90

FLASH Collection

DIMMER INCLUSO
DIMMER INCLUS
Mit DIMMER

MIRRORS *MIROIRS* SPIEGEL

Note: (Pag. 94)

A

4 mm smooth edged mirrors with internal LED lighting (LED BAND), LED diffusion, with 220V transformer and wall mount. 4000°K NATURAL LIGHT supplied as standard, 2700°K WARM LIGHT and 6000°K COLD LIGHT upon request. NEW front DIMMER SWITCH.

Miroirs 4 mm, bords droits avec éclairage intérieur à LED (LED BAND) et rétroéclairage Led diffusion, transformateur 220V. Système de fixation murale inclus.

LUMIÈRE NATURELLE 4000°K standard, sur demande LUMIÈRE CHAUDE 2700°K ou FROIDE 6000°K. Fournis avec le NOUVEL INTERRUPTEUR LUMINEUX DIMMER frontal (sur demande avec interrupteur sensor).

Spiegel 4 mm stark, mit rechteckigem Kantenschliff und integrierter Beleuchtung (LED BAND), 220V Transformator, Sensorschalter und Wandbefestigung. Serienmäßig NATÜRLICHES LICHT 4000°K, auf Wunsch KALT LICHT 6000°K oder WARMLICHT 2700°K. Die Beleuchtung wird durch den neuen DIMMER an der Vorderseite des Spiegel eingeschaltet.

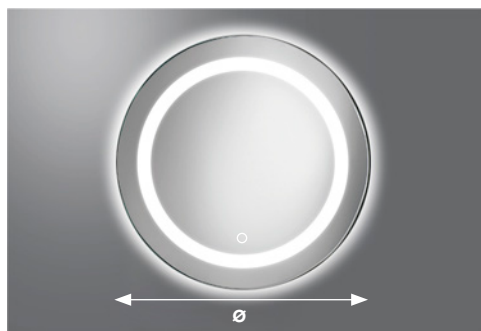
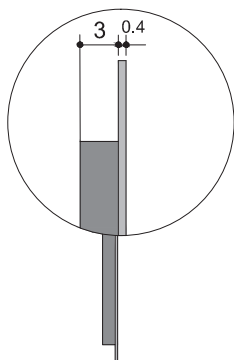

Art. TE90D

Art. Ø cm.

TE90D 90

OPTIONAL

SU MISURA FLASH Collection

MIRRORS *MIROIRS* SPIEGEL

4 mm smooth edged mirrors with internal LED lighting (LED BAND), LED diffusion, with 220V transformer and wall mount. 4000°K NATURAL LIGHT supplied as standard, 2700°K WARM LIGHT and 6000°K COLD LIGHT upon request. NEW front DIMMER SWITCH.

Miroirs 4 mm, bords droits avec éclairage intérieur à LED (LED BAND), avec ou sans rétroéclairage Led diffusion, transformateur 220V. Système de fixation murale inclus. LUMIÈRE NATURELLE 4000°K standard, sur demande LUMIÈRE CHAUDE 2700°K ou FROIDE 6000°K. Fournis SUR DEMANDE avec le NOUVEL INTERRUPTEUR LUMINEUX DIMMER frontal.

Spiegel 4 mm stark, mit rechteckigem Kantenschliff und integrierter Beleuchtung (LED BAND), 220V Transformator, Sensorschalter und Wandbefestigung - erhältlich mit oder ohne LED Diffusion (Indirekte Beleuchtung). Der satinierte LED BAND Lichtausschnitt ist an den äußeren Enden leicht abgerundet. Serienmäßig NATÜRLICHES LICHT 4000°K, auf Wunsch KALTLICHT 6000°K oder WARMLICHT 2700°K. Die Beleuchtung wird durch den neuen DIMMER an der Vorderseite des Spiegels eingeschaltet.

Note: (Pag. 94)

Z

MUS
Pag.98

MIX
Pag.100

SLG
Pag.101

MM10
Pag.103

MM12
Pag.103

NOF
Pag.104

OBL
Pag.105

ING1
Pag.106

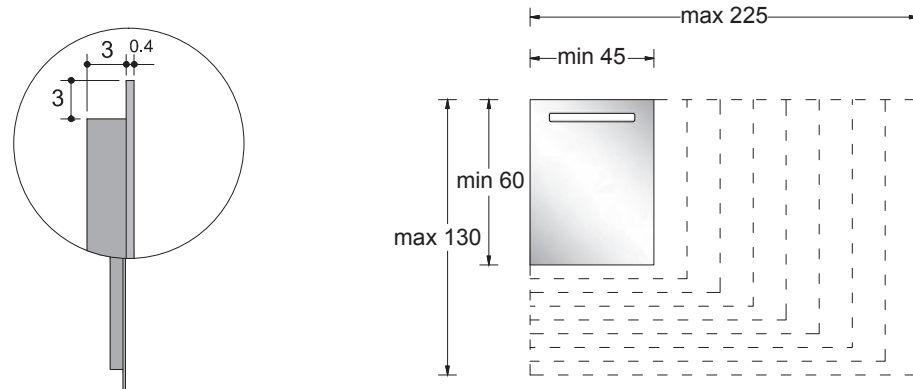

TF5



TFD5



Art.	Price per sq.m. (minimum order 0,75 sq.m).	LED band per linear metre	LED diffusion per linear metre calculated on the perimeter of the mirror.	RGB system per linear metre + (for remote control - compulsory).	Front dimmer switch upon request
Art.	<i>Prix au m² (minimum facturable 0,75 m²).</i>	<i>Led BAND (calculée au mètre linéaire)</i>	<i>Led Diffusion au mètre linéaire (calculée sur le périmètre du miroir).</i>	<i>Éclairage par système RGB au mètre linéaire (pour télécommande obligatoire).</i>	<i>Interrupteur dimmer frontal sur demande</i>
Art.	Preis pro Quadratmeter (minimale Bestellung 0,75 m ²).	LED BAND berechnet pro Laufmeter	LED Diffusion pro Laufmeter aufgerechnet auf den Umfang des Spiegels.	RGB Farblicht pro Laufmeter (für Fernbedienung OBLIGATORISCH).	Auf Anfrage Sensor Schalter

TF5

	EXAMPLES FOR CALCULATION OF PRICE	EXEMPLES POUR LE CALCUL DES PRIX	BEISPIELE ZUR PREISBERECHNUNG	
LED BAND	Exemple of mirror 140x75 ml 1,40 led band	<i>Exemple miroir cm. 140x75 ml 1,40 led band</i>	Beispiel: Spiegel 140x75cm 1,40 Meter LED-BAND	mq. 1,05 1,05x409,00 2x269,00
LED BAND + LED DIFFUSION	Exemple of mirror 120x85 ml 1,2 led band ml 4,10 led diffusion	<i>Exemple miroir cm. 120x85 ml 1,2 ml led band ml 4,10 led diffusion</i>	Beispiel: Spiegel 120x85cm 1,2 Meter LED-BAND 4,10 Meter LED-DIFFUSION	mq. 1,02 1,02x409,00 1,2x269,00 4,1x76,00